

Window Intercom System

DCSTS-K071



Installation & User Guide

December 2020

Window Intercom System

DCSTS-K071



Installation & User Guide

December 2020

Contents

Product Overview	3
Components	3
Connections	4
Installation Instructions	5
Speaker & Microphone Kit Installation	6
Staff Side Installation	6
Customer/Visitor Installation	7
Hearing Loop Installation	9
Amplifier Setup	10
Troubleshooting	12
Engineer's Mode	13

Contacta has a policy of continuous product development, and therefore small specification changes may not be reflected in this manual. Images, labels, packaging, accessories and product colours are subject to change without notice.

Product Overview

Window intercom systems provide assistance for clear communication where normal speech is impaired by use of glass, a security screen or other similar barriers.

There is an optional hearing system loop facility, providing additional assistance for hearing device wearers.

Speaker & Microphone Components

1. Speaker Pod
2. Mouse Microphone
3. Staff Pod
4. Double-Sided Fixing Pad

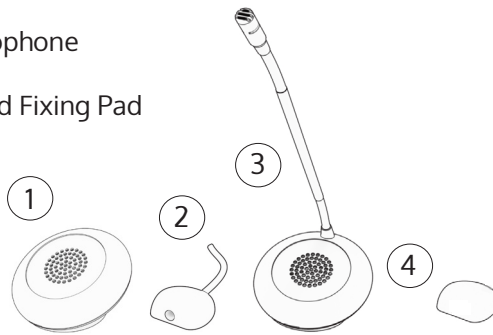

General Components

1. Installation and User Manual
2. Amplifier
3. IEC Lead
4. Power Supply
5. Hearing Loop Aerial (optional)

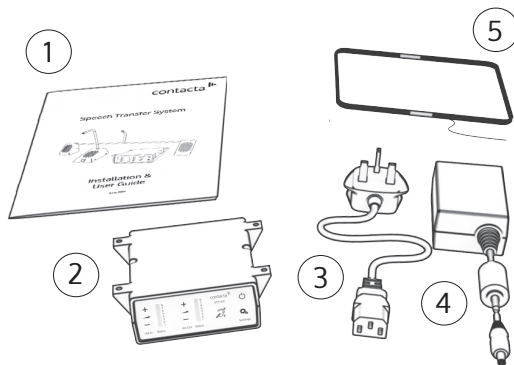

Fixing Kit:

- Adhesive Clip x 10
- No.6 x 1/2" Countersunk Screws x 15
- P-Clips x 6

Connections

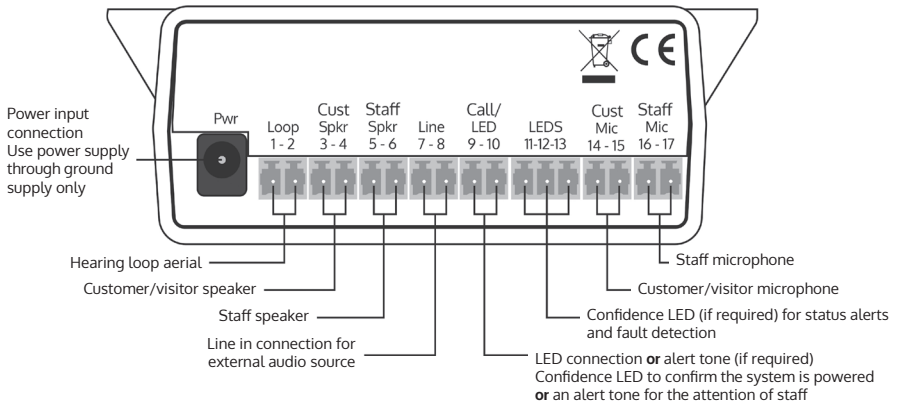
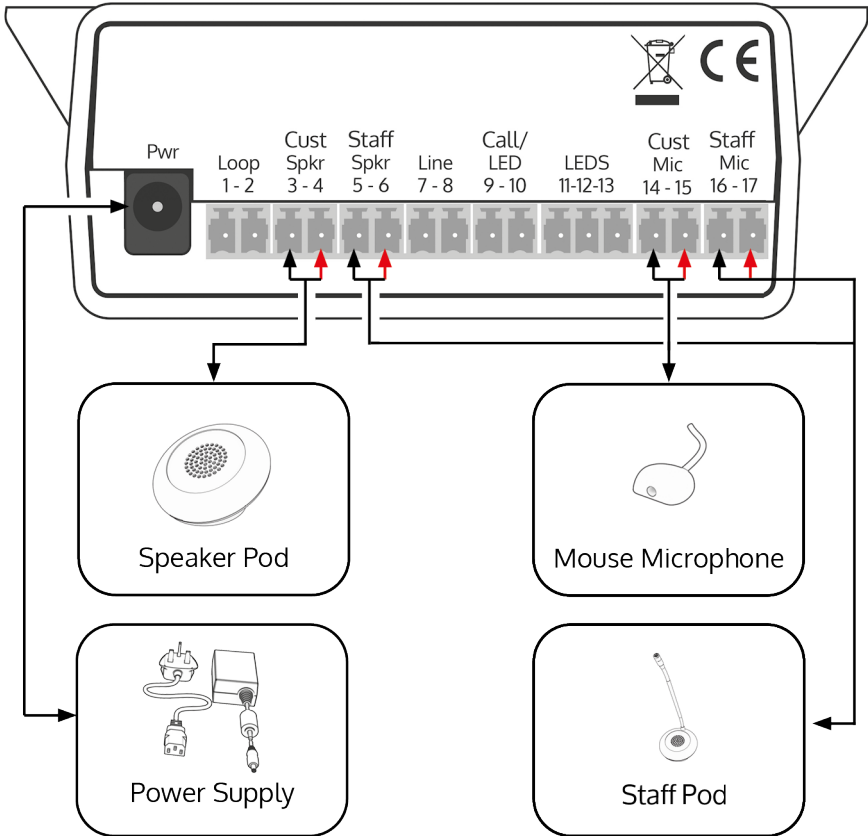

Installation Instructions

We recommend that installation is carried out by a qualified engineer, adhering to relevant standards.

Check the contents of the box to familiarise yourself with the components.

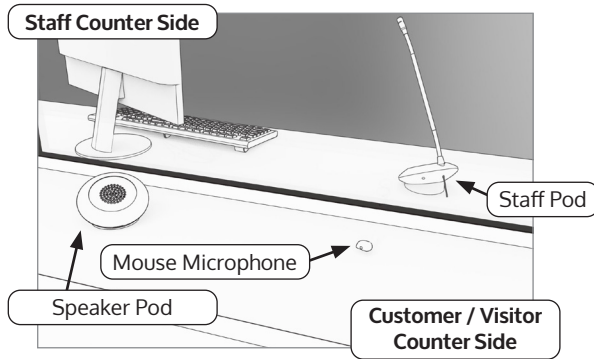

Recommended Tools

A basic toolkit recommended to install the system will include:

- Screwdrivers (Flat or Blade 2.5mm and Phillips Head PH2)
- Battery or Mains Drill
- Drillbits: 2mm, 3mm, 5mm and 7mm
- Cable Tacking Gun (10mm)
- Wire Cutters/Strippers
- Tape Measure
- Pencil or Marker Pen
- Cable Ties
- Trunking

Trim cables if necessary (excluding the power supply) to the required length to connect to the back of the amplifier. Bare approximately 6mm of the cable ends to connect to the 2 pin plugs.

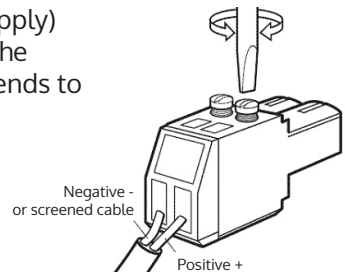

Amplifier Installation

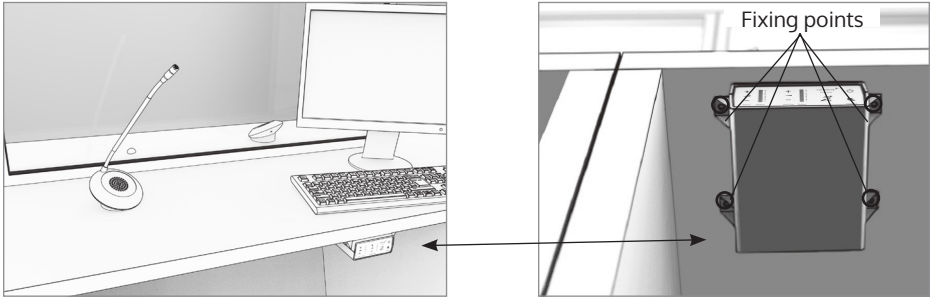

1. Place the amplifier under the staff counter, ensuring that it will not obstruct staff when they are sitting.
2. Mark the four fixing points for the amplifier under the counter.
4. Drill and fix the amplifier in place using the supplied screws.
6. Install the amplifier's power supply close to a power socket outlet using the supplied mounting bracket and fixing screws.

Microphone & Speaker Installation

1. Place the staff pod on the staff side of the counter top, ensuring it does not cause an obstruction and is as close to staff as possible.
2. Place the speaker pod on the customer side of the counter top, ensuring it does not cause an obstruction.
3. Place a mouse microphone on the customer/visitor side of the counter top, ensuring it does not cause an obstruction and is as close to customers/visitors as possible.

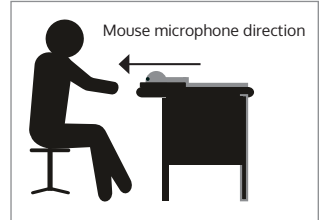

For best performance all mouse microphones should be fitted facing the user as shown in the image on the right. The recommended minimum distance between the mouse microphone and speaker pod is 300mm.

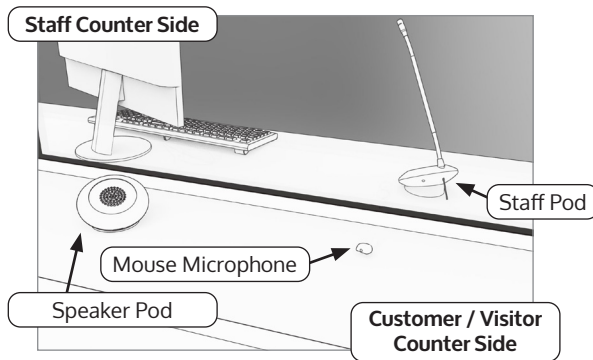

4. Speaker pods and staff pods can be either free standing or fixed. Move to step 10 if you do not wish to fix the pods to the counter.
5. Use cable management holes in the counter to run the staff pod, speaker pod, and mouse microphone cables to the amplifier. If there are not already cable management holes, drill suitable locations near the rear of both the staff and customer sides of the counter.
6. Remove the top of the pods to gain access to the fixing points.
7. Mark the two fixing points on the bottom of both pods. Then mark two

cable holes to be drilled, one for both the customer/visitor side and the staff side.

8. Ensure there will be access to retrieve the cables then drill the holes.
9. Fix the pods to their respective counters.
10. To fix the mouse microphone to a surface, use the provided double-sided fixing pad or screw through the screw-hole in its cap.
11. Feed the wires through the cable management holes.
12. Avoid loose or trailing cables. Use trunking or to prevent trip hazards or units being tugged from their position.
13. Route all cabling neatly to the amplifier location on the staff side.

Hearing Loop Installation (Optional)

The aerial should be fixed under the desk-top or counter centrally on the customer or visitor side, one half mounted horizontally under the counter and the other half mounted vertically, facing the customer/visitor (as in the first scenario below).

Position the aerial under the counter using either the provided P-clips or another fixing method of your choice. See the diagram below for recommended positioning.

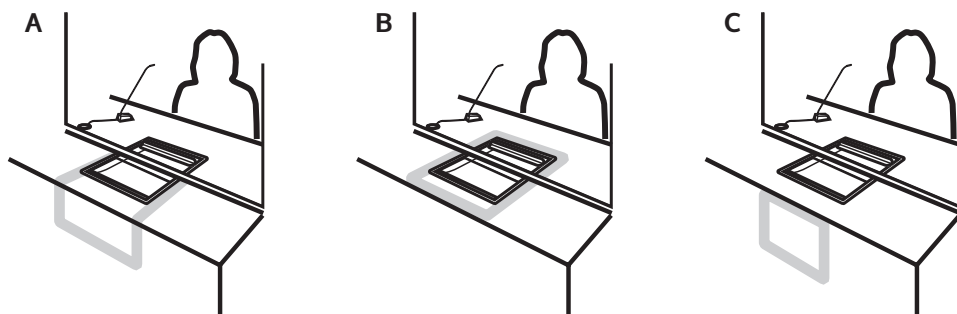

A is the optimum layout for a counter hearing loop.

B and C are acceptable only if A is not possible and the layout is aligned so that the magnetic field will be directed towards user's head heights.

Ensure all hearing loop signage is displayed clearly.

Amplifier Setup

Overview of Front Panel Buttons

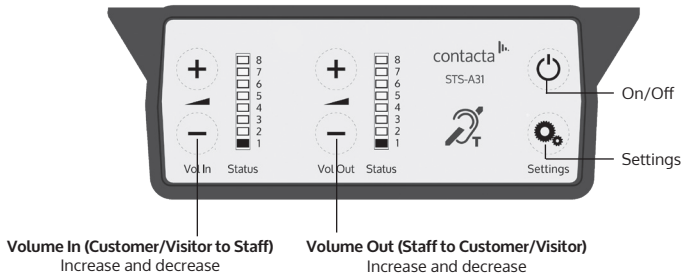

Setup

1. Connect all green plugs to the back of the amplifier, following the locations printed above the sockets (see page 4).
2. Power on the amplifier by pressing the On/Off button.
3. When powered and in normal operational mode the amplifier will display Volume In LED 1 and Volume Out LED 1 as steady green.
4. When the amplifier is switched off, all audio is muted and none of the LEDs are illuminated. Pressing any button will turn the amplifier on again.
5. Adjust Volume In and Volume Out to a comfortable level.
6. Press and hold the Volume In (+) or (-) buttons to increase or decrease the level. The corresponding LED bar will show the volume setting.
6. Ensure the mouse microphones are placed as close to their intended users as possible.
7. Check the amplifier is fully functional by ensuring the red 'fault' light is NOT showing on the front.
8. **The Amplifier is now set up.**

Our Window Intercom System amplifiers are pre-set to volume levels suitable for nearly all users. Should you need to adjust the Maximum Volume, Ducking or Hearing Loop levels outside of the pre-set amplifier parameters, use Engineer's Mode (see page 13).

Fault Diagnosis LEDs

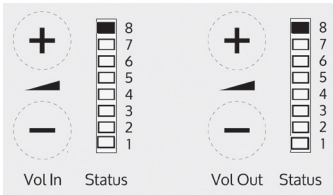

- Volume In LED 8 will stay red if there is a fault with the staff microphone.
- Volume Out LED 8 will stay red if there is a fault with the customer/visitor microphone.
- Volume In LED 8 will flash red if there is a fault with the loop (e.g. a broken aerial).

Factory Default Settings

To return the amplifier the factory default settings:

1. Unplug the power supply and then reconnect it.
2. Press the On/Off button and Volume In (-) button together, then release.
3. The Volume In LED bar will have all LEDs illuminated, while the Volume Out LED bar will display the firmware revision number in a fixed pattern of LEDs. This indicates that default settings have been restored.

Troubleshooting

Symptom	Possible Fault	Action
There is no power detected through the amplifier (and there is power at the socket).	1) Power jack not plugged in or faulty. 2) Plug fuse has blown. 3) Faulty power supply unit. 4) Faulty amplifier.	1) Check power jack is firmly plugged in. 2) Replace fuse. If it blows again, replace the power supply unit. 3) Replace the power supply unit. 4) Replace amplifier.
The red LED is illuminated on front panel.	1) Constant red LED: Staff or customer/visitor microphone fault. 2) Red LED comes on after speech: Induction loop fault.	1) Ensure microphone is wired correctly and firmly plugged in. Try alternative microphone to ensure port is working. 2) Ensure induction loop connector is wired correctly and firmly plugged in.
I can't hear audio through the induction loop.	1) Induction loop or microphone is disconnected. 2) Loop tester has a fault.	1) Check instructions for correct connections and, if possible, check the hearing device with a known working hearing loop. 2) Ensure loop tester has a new set of batteries.
I can hear interference through speakers (buzzing / whistling / hissing).	1) Unscreened or poorly earthed third party equipment is being used in close proximity. 2) Internal volume gain set to high. 3) Incorrect power supply being used.	1) Switch off any third party equipment to identify the source of interference. 2) Access the amplifier Engineer's Mode to adjust the internal settings. 3) Ensure that our grounded power supply unit is connected.
Amplifier goes into feedback.	1) Internal volume gain set too high. 2) Microphone positioned too close to speaker.	1) Access the amplifier Engineer's Mode to adjust the internal settings. 2) Move the microphone to a location further from the speaker.
Unit does not go into power saving mode.	1) Ambient noise in area is too high.	1) Switch off any air con systems, desktop fans and/or computers to reduce ambient noise.

If no action is successful please seek assistance from your distributor or a Contacta installer.

Engineer's Mode

Engineers Mode allows you to adjust the Volume In and Out levels, Ducking levels and Hearing Loop levels to better suit your environment and achieve the best possible performance.

Before entering Engineer's Mode, cycle the power. To do this either:

- Switch the power off at the mains socket and back on again
- Remove the power connector and re-insert it

To enter Engineer's Mode, simultaneously press and release the following buttons within 20 seconds of cycling the power:

- Settings button
- Volume In increase button
- Volume Out increase button

Number 1 LED on the Volume In will flash green to indicate that you are in Engineer's Mode.

The on/off and settings buttons in Engineer's Mode operate as follows:



Move to the next setup area



Save and exit Engineer's Mode

The amplifier will automatically exit Engineer's Mode if no buttons are pressed for 2 minutes.

There are 3 editable setup areas in Engineer's Mode. You will always enter setup area 1 first. The green Volume In LED bar will flash to indicate which setup area you are in.

Setup Area 1: Maximum Volume Adjustment (LED 1 flashes)

Setup Area 1 allows you to adjust the Volume In and Volume Out levels to further optimise the system for the environment in which it is installed.

Increase maximum staff volume level

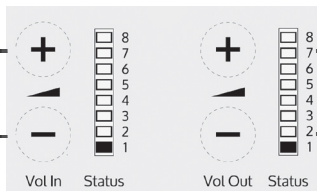

Decrease maximum staff volume level

Increase maximum customer volume level

Decrease maximum customer volume level

1. Ensure the customer and staff volumes are turned completely down.
2. Adjust staff (Volume In) volume to a comfortable level. Press and hold the Volume In (+) or (-) buttons to increase or decrease the level. The corresponding LED bar will show the volume setting.
3. Increase customer (Volume Out) volume until feedback is heard. Press and hold the Volume Out (+) or (-) buttons to increase or decrease the level. The corresponding LED bar will show the volume setting.
4. Decrease customer (Volume Out) volume until feedback is eliminated.

Setup Area 2: Ducking Adjustment (LED 2 flashes)

Setup Area 2 allows you to adjust the Ducking level or to turn it on/off.

The ducking function is provided to reduce feedback on a window intercom system. Feedback occurs when the overall setting of both volume controls is too high. The ducking system works by detecting which microphone in the conversation is being used, and temporarily reducing the volume setting.

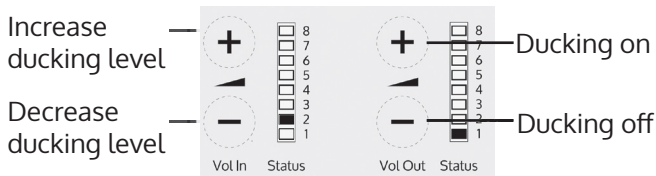

Setup Area 3: Hearing Loop Drive Adjustment (LED 3 flashes)

Setup Area 3 allows you to adjust the Hearing Loop Drive or to turn it on/off.

Hearing loops improve communication by enabling hearing device users to hear sound sources directly, cutting out background noise.

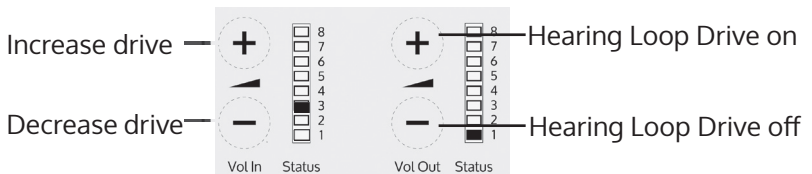

The drive levels should be adjusted so the red LED 8 is illuminated only when there are peaks in the speech volume.

If the amplifier does not have a loop attached, turn the Hearing Loop Drive off as indicated in the diagram above.



Window Intercom STS-A31H Amplifier
Setup Video



Window Intercom Unboxing &
Positioning Guide Video

Local dealer



Audio Accessibilité By ARCHEAN Technologies

✉ 1899 Avenue d'Italie, ZI Alba sud II, 82000 Montauban, France

☎ +33 (0)5 63 93 50 00

✉ contact@audioaccessibilite.tech

www.audioaccessibilite.tech