

Home Loop

DCHLD3 Hearing Loop Driver

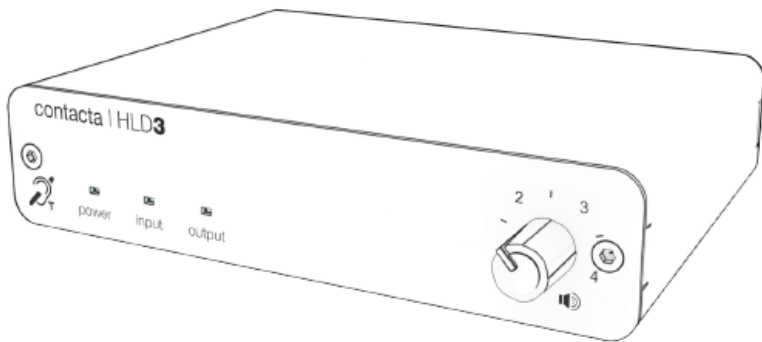

Installation & User Guide

May 2017

Contents

Product Overview	3
Components	3
Recommended Tools	4
Installation Instructions	4
Connections	6
Hearing Loop Driver Front Panel	7
Hearing Loop Driver Rear Panel	8
Using the System	9
Maintenance	9
Troubleshooting	10

Product Overview

Our Home Loop is a sleek and powerful hearing loop driver that connects to televisions, music systems, and other audio devices.

It enables hearing device wearers to listen wirelessly and directly from a sound source. Integrated clear audio processing gives the user outstanding sound quality, enhancing speech and music clarity.

Components

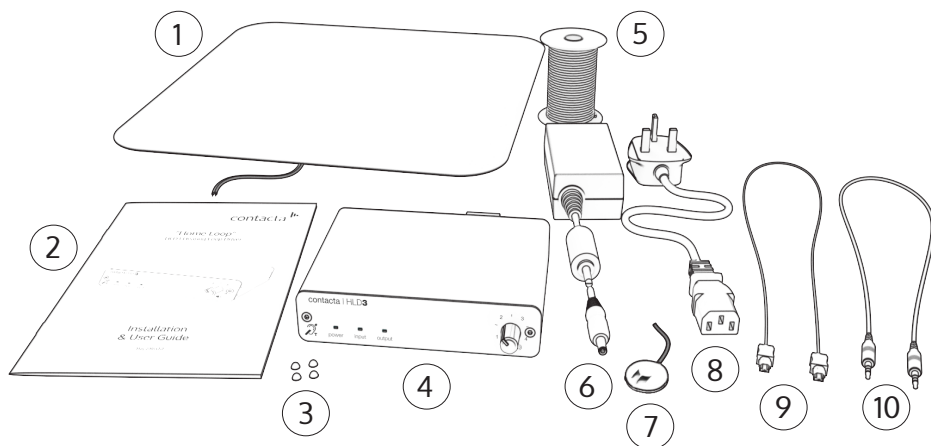

1. Hearing Loop Pad
2. Installation & User Guide
3. Rubber Feet x 4
4. HLD3 Hearing Loop Driver
5. Reel of Cable

6. Power Supply
7. Boundary Microphone
8. IEC Lead
9. Optical Cable
10. Auxiliary Cable

Recommended Tools

- Suitable cable fixings such as gaffer tape or cable clips.
- 3mm flat head screwdriver for adjusting high frequency compensation.

Installation Instructions

Installing the Hearing Loop Pad

The hearing loop pad should be installed on the seat used most frequently by the hearing device user.

Installation:

1. Place the hearing loop pad underneath the seat that the hearing device user will sit in. Ideally, it should be positioned under the chair cushion, fixed underneath the chair, or placed on the floor.
2. Route the wire to the hearing loop driver and fix it around the edge of the room.



Use suitable fixings such as gaffer tape or cable clips to ensure the wire does not act as a trip hazard.

3. See page 6 for information on how to connect the hearing loop pad cable to the hearing loop driver.

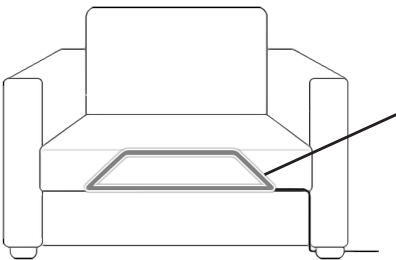

Hearing loop pad placed underneath the cushion of the chair.

Hearing loop pad fixed underneath the chair or placed on the floor.

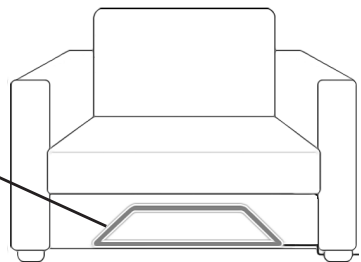

Installing the Hearing Loop Cable

If there is more than one person using the hearing loop, or you wish to use the hearing loop in multiple locations within the room, the hearing loop cable will be more suitable as it creates a larger magnetic field. The hearing loop cable can be installed either around the room or around certain pieces of furniture.

Installation:

1. Lay the hearing loop cable around either the perimeter of the room or around the sofa/chair.
2. Ensure both ends of the cable reach the hearing loop driver and can be connected easily.
3. Fix down the hearing loop cable, ideally under the carpet.



Use suitable fixings such as gaffer tape or cable clips to ensure the hearing loop cable does not act as a trip hazard.

4. See page 6 for information on how to connect the hearing loop cable to the hearing loop driver.

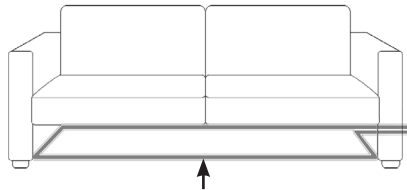

Hearing loop cable around the base of the sofa/chair to form a loop.

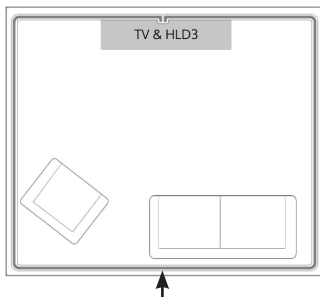

Hearing loop cable shaped around the perimeter of the room.

Connections

Connect both ends of the wire to the loop terminals on the driver as in the diagram below. Either wire can be connected to either terminal.

Hearing Loop Pad Cable

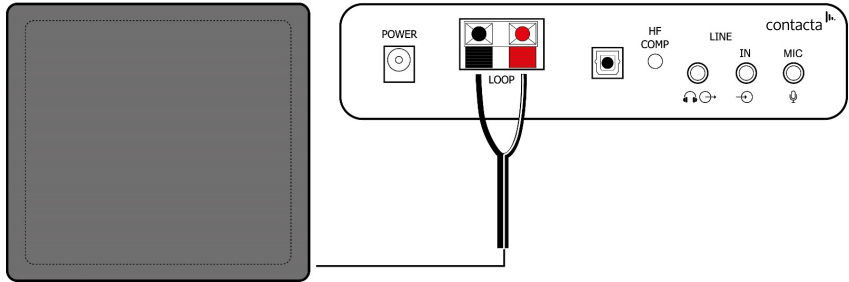

Hearing Loop Cable

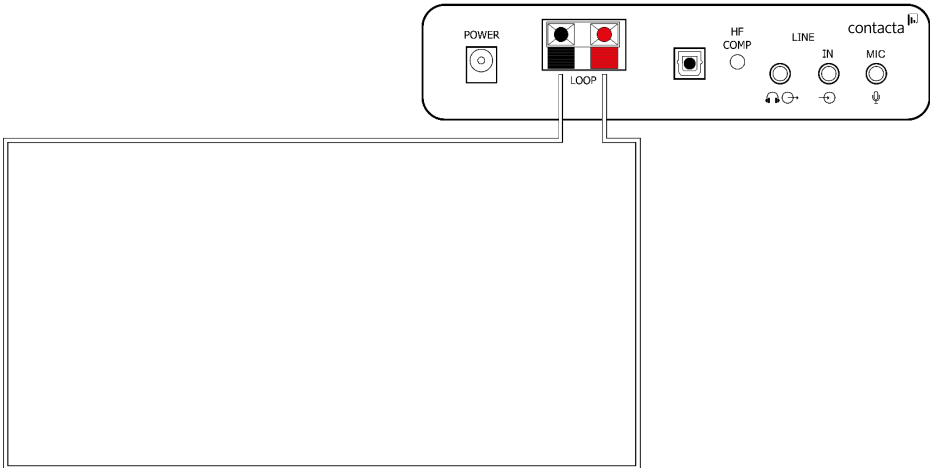

Hearing Loop Driver Front Panel

There are 3 LED indicators on the front panel.

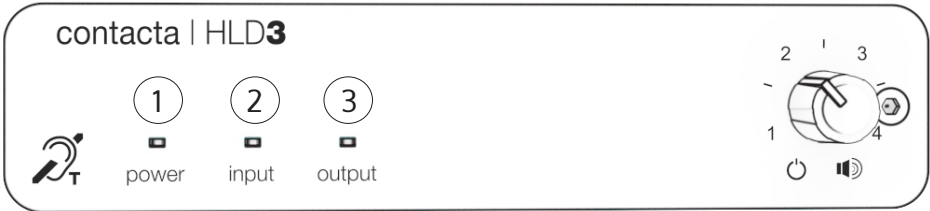

1. Power

The Power indicator will light up when the hearing loop driver has been switched on and has power connected to it

When there is no input signal, the indicator will flash once every minute.

2. Input

This indicator will light up when audio is coming through the loop from an audio source such as a television or music system.

3. Output

When there is audio being driven through the loop, the output indicator will light up.

The indicator will either flash or remain constant, depending on the level.

The output indicator will flash continuously when a loop is not connected.

Hearing Loop Driver Rear Panel

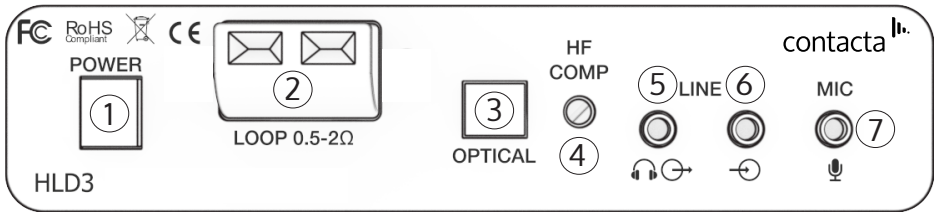

1. Power
2. Hearing Loop Connection
3. Optical/Digital In
4. High Frequency Compensation
5. Line Out (only follows signal from the Optical/Digital In)
6. Line In
7. Microphone

Optical Cable

If your television/sound source has an optical output available, use the optical cable to connect it to the driver's Optical/Digital In (3 in the diagram above). The Line Out jack (5 in the diagram above) is driven only from the optical cable input. The HLD3 accepts PCM digital audio.

HLD3

TV/Sound
Source



Auxiliary Cable

If your television/sound source doesn't have an optical output available, use the auxiliary cable to connect it to the driver's Line In (6 in the diagram above).

HLD3

TV/Sound
Source



High Frequency Compensation

Metal loss occurs when a large amount of metal in the surrounding area affects your hearing loop's higher audio tones. To adjust for this, turn the HF Comp adjuster (4 in the diagram above) clockwise until the higher pitched sounds are at a suitable strength.

Using the System

1. To turn on the HLD3, turn the volume control knob (on the right of the front panel) clockwise until the power indicator lights up.
2. Move to the position of the hearing loop. If using a hearing loop pad, sit on the chair with the pad installed underneath.
3. Switch the hearing device to the "T" position or turn on the loop listener, then turn on the audio source.
4. Audio is picked up by the telecoil in the hearing device.
5. Adjust the volume on the hearing loop driver as necessary. The audio source volume control will not change the volume heard by the hearing device.

There's nothing more you need to do!

7. Turn the volume control knob anti-clockwise until it clicks to power off when the Home Loop is not being used.

Maintenance

To keep the system at its peak performance, the following procedures should be carried out on a regular basis:

- Ensure all connectors are firmly inserted into their sockets.
- Do not stretch cables.
- Clean the driver and the microphone with a dry soft cloth/ cleansing wipes. Do not use solvent based cleaners.
- Do not allow cleaning fluids to enter the driver or back ports/vents of the microphone.

Troubleshooting

Symptom	Possible Fault	Action
No power detected in the hearing loop driver / power indicator isn't illuminated.	1) Power cable not plugged in or faulty. 2) Faulty power supply unit. 3) Plug fuse has blown. 4) Driver has a fault.	1) Check power cable is firmly plugged in. 2) Change the power supply unit. 3) Change the plug fuse. If it blows again, contact your dealer. 4) Contact your local dealer.
Input light isn't illuminated.	1) Sound source isn't powered on. 2) Input disconnected. 3) Driver has a fault.	1) Make sure the television or sound source is switched on. 2) Ensure either the optical out or line out is connected to the HLD3 from the audio source. 3) Contact your local dealer.
Output light isn't illuminated.	1) Volume is too low. 3) Hearing loop pad or cable incorrectly installed or disconnected. 3) Driver has a fault.	1) Turn up the volume on the driver. 3) See page 4 and ensure all installation instructions have been followed carefully. 3) Contact your local dealer.
No audio is heard through the hearing loop.	1) Volume is too low. 2) If using a hearing loop pad, the hearing device user isn't seated above the hearing loop pad. 3) Hearing loop pad or cable incorrectly installed or disconnected. 4) Driver has a fault.	1) Adjust the volume on the driver and on the hearing device. 2) Make sure the hearing device wearer is seated where the hearing loop pad is located. 3) See page 4 and ensure all installation instructions have been followed carefully. 4) Contact your local dealer.

Symptom	Possible Fault	Action
Interference (buzzing/whistling/hissing) is heard through the hearing loop.	1) Incorrect power supply is being used. 2) Unscreened or poorly earthed third party equipment is being used in close proximity.	1) Ensure that the supplied grounded power supply is being used. 2) Switch off any third party equipment to identify the source of interference.
No sound when using headphones.	1) The optical input isn't being used. 2) Driver has a fault.	1) This function is only available when using the optical input. 2) Contact your local dealer.

If you are still experiencing problems, please contact your local dealer.



Local dealer

Audio

ACCESSIBILITÉ

Audio Accessibilité By ARCHEAN Technologies

✉ 1899 Avenue d'Italie, ZI Alba sud II, 82000 Montauban, France

☎ +33 (0)5 63 93 50 00

✉ contact@audioaccessibilite.tech

www.audioaccessibilite.tech